



NANYANG PRIMARY SCHOOL

PRIMARY 4 SCIENCE

**Practice Paper
2021**

BOOKLET A

Total duration for Booklets A and B: 1 h 45 min

Name: _____ ()

Class: Primary 4 ()

**DO NOT OPEN THIS BOOKLET UNTIL YOU ARE TOLD TO DO SO.
FOLLOW ALL INSTRUCTIONS CAREFULLY.**

Booklet A consists of 24 printed pages including this cover page.

Section A: Multiple Choice Questions

For each question from 1 to 28, four options are given. One of them is the correct answer. Indicate your choice in this booklet and shade the correct oval (1, 2, 3 or 4) on the Optical Answer Sheet provided.

1. Which one of the following is a living thing?

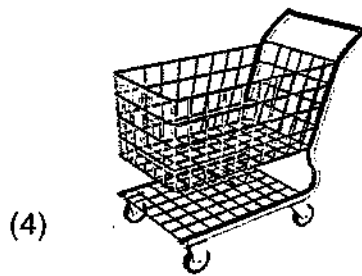
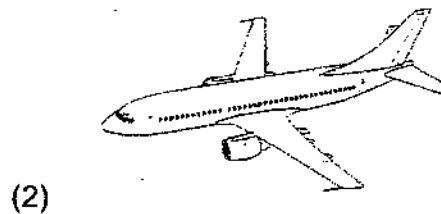
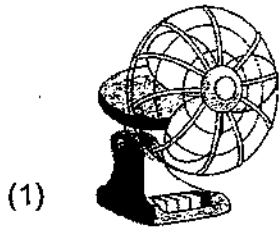

2. Study the classification chart below.

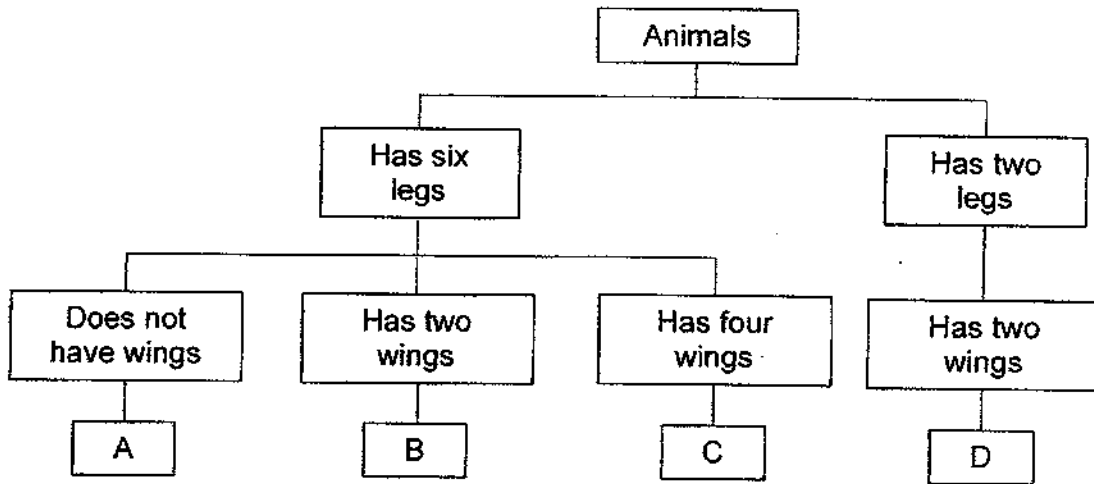

Based on the classification chart above, in which of the groups, A, B, C or D, would you place the following in?

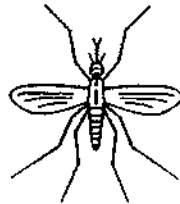

- (1) A
- (2) B
- (3) C
- (4) D

3. Study the diagram below.

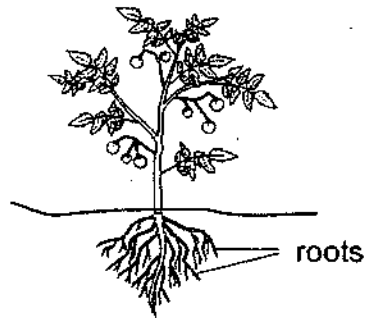

The roots help the plant to _____.

- (1) make food
- (2) grow upright
- (3) absorb water
- (4) absorb sunlight

4. Which organ system is shown in the diagram below?

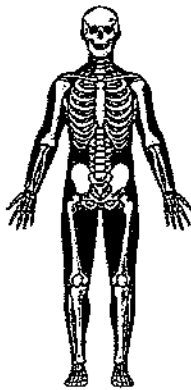

- | | |
|------------------------|------------------------|
| (1) Skeletal system | (2) Muscular system |
| (3) Circulatory system | (4) Respiratory system |

5. The diagram below shows the growth of a young plant with two missing stages A and B.

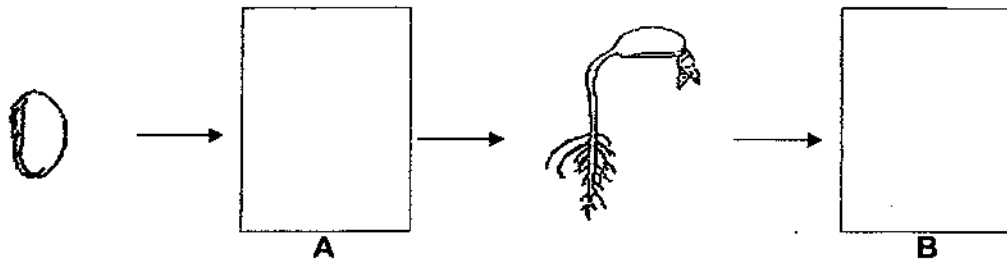

Which one of the following shows the correct stages for A and B?

	A	B
(1)		
(2)		
(3)		
(4)		

6. In which of the following will the two magnets push each other away?

(1)



(2)

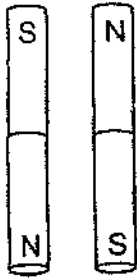

(3)

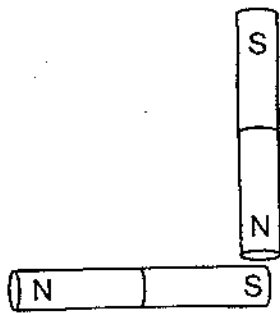

(4)

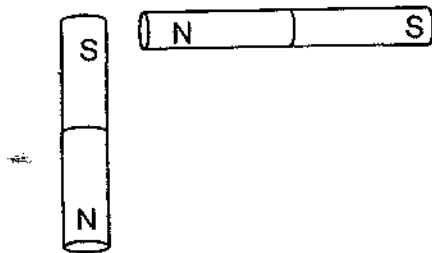

7. The diagram below shows an umbrella.

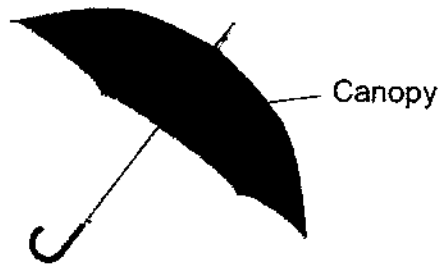

Plastic is used to make the canopy of the umbrella because plastic _____.

- (1) breaks easily
- (2) is waterproof
- (3) is non-magnetic
- (4) can float on water

8. Look at the picture below.

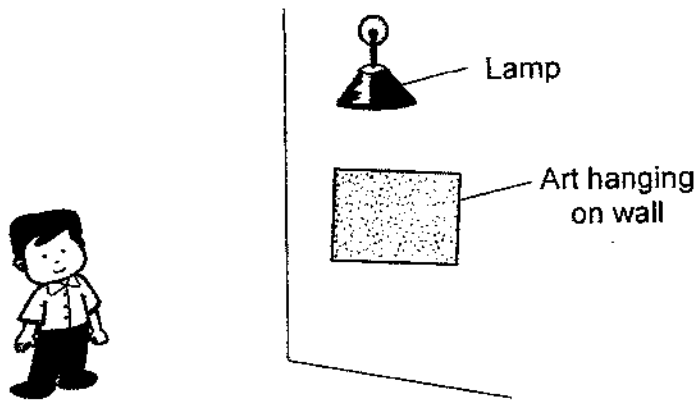

Which one of the following explains why Ming Le can see the drawing on the wall?

Key:
→ represents the direction of light ray

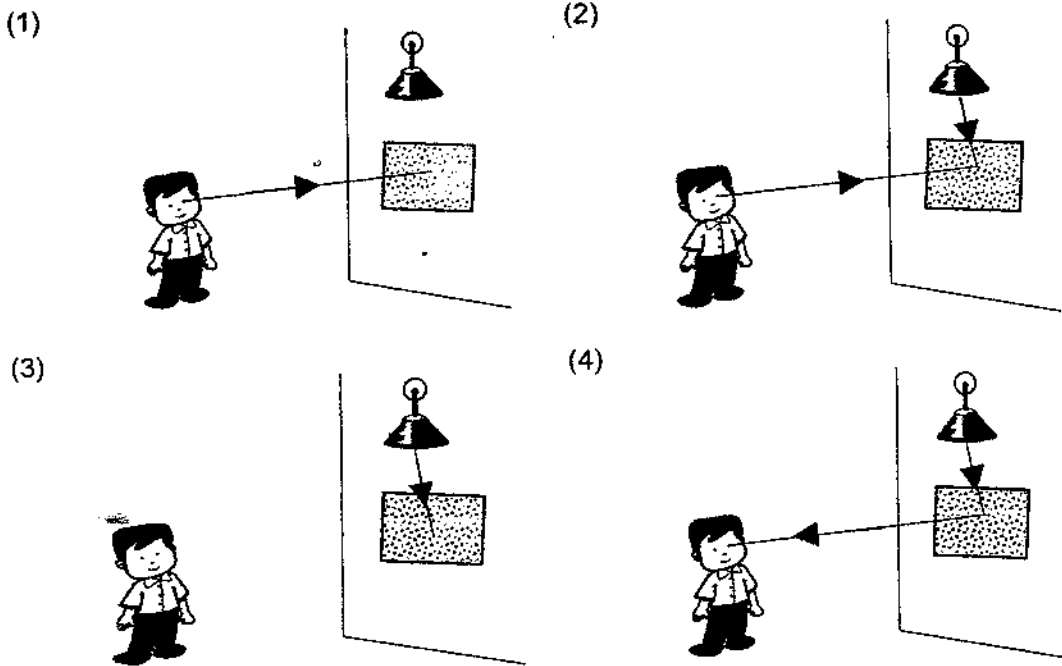

9. John wants to measure the temperature of hot water in a beaker.

Which one of the following diagrams shows the correct position of the thermometer when taking the temperature of the water?

(1)

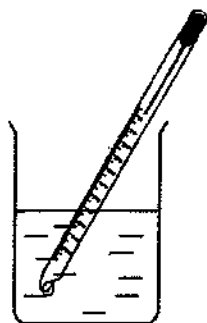

(2)

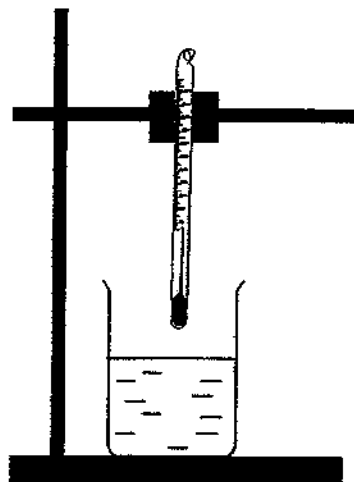

(3)

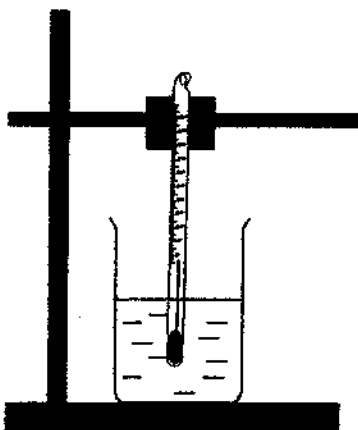

(4)

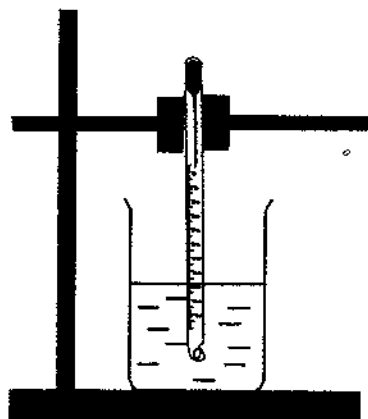

10. Which one of the following properties is correct for both air and water?

- (1) They have mass.
- (2) They can be seen.
- (3) They have fixed shapes.
- (4) They have fixed volumes.

11. The classification chart below shows how some living things are classified.

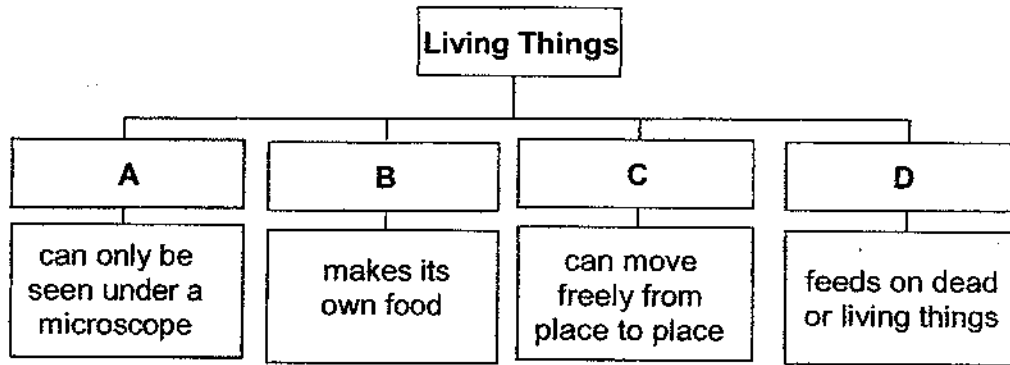

Which of the following correctly represents the headings A, B, C and D?

	A	B	C	D
(1)	Bacteria	Flowering Plants	Fungi	Animals
(2)	Bacteria	Ferns	Animals	Fungi
(3)	Fungi	Flowering Plants	Bacteria	Animals
(4)	Fungi	Animals	Flowering Plants	Ferns

12. Tanya wanted to conduct an experiment to find out if plants needed sunlight to grow well. She prepared two set-ups, X and Y, each with a similar potted plant placed in a clear glass container as shown below.

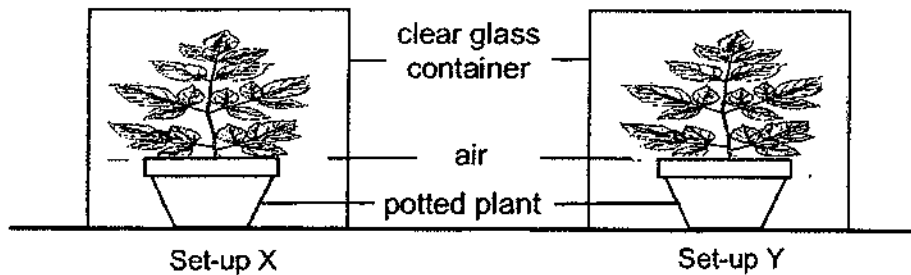

Which of the following conditions must she keep the same in order to conduct a fair test?

- A type of soil
- B amount of water used to water the plants
- C both plants to be placed near an open window

- (1) A and B only
- (2) A and C only
- (3) B and C only
- (4) A, B and C

13. Osman found living thing Y at a park and made some observations about it for 2 weeks. He recorded his observations below.

- has gills
- feeds on insects
- lays egg in water
- has scales on its body

Which one of the following groups of animals does Y most likely belong to?

- (1) Bird
- (2) Fish
- (3) Insect
- (4) Amphibian

14. Jiahao conducted an experiment to find out what conditions would affect the growth of mould. He placed a piece of half-cut juicy apple in each of the three identical sealed containers, P, Q and R. Containers P and Q were placed in a room with a temperature of 30°C. Container R was placed in the freezer with a temperature of 0°C. The conditions of the set-ups are shown in the table below.

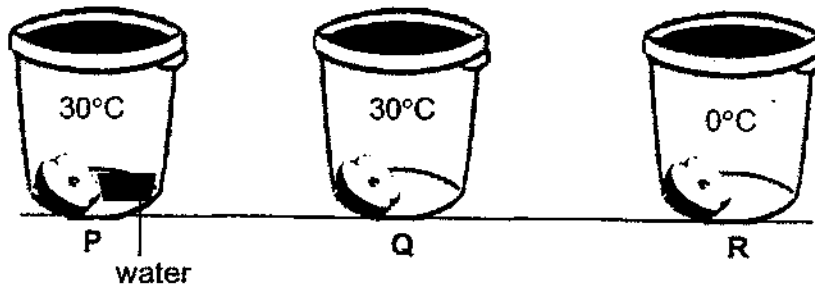

Container	P	Q	R
Temperature	30°C	30°C	0°C
Other condition(s)	sealed container with water	sealed container	sealed container

In which set-ups would Jiahao most likely observe mould growing on the apple after 1 week?

- (1) P and Q only
- (2) Q and R only
- (3) P and R only
- (4) All of the above

15. Beng Huat conducted an experiment using two similar plants, X and Y, and placed them in identical containers as shown below. Both containers were filled with the same amount of water at the start of the experiment.

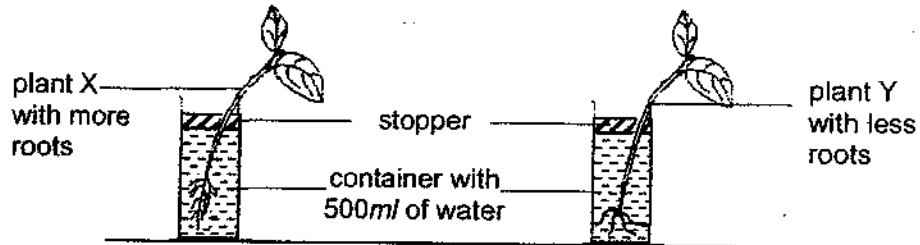

He measured the amount of water in the containers after one week and recorded the results in the table shown below.

Plant	Start of experiment (ml)	End of experiment (ml)
Plant X	500	110
Plant Y	500	300

Based only on the results above, what could Beng Huat conclude from his experiment?

- (1) Plant with less roots does not grow well.
- (2) Plant with less roots takes in less water for the plant.
- (3) Plant with more roots allows the plant to make more food.
- (4) Plant with more roots holds the plant more firmly to the ground.

16. Study the diagram of the human organ systems below.



System E



System F

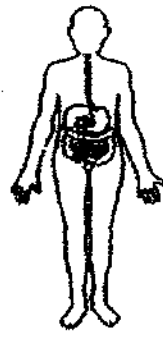

System G



System H

Danish made the statements below.

- A All the systems need to work together in order for us to live.
- B System F directly protects our organs such as the heart.
- C Systems G and H work together to take in and remove air from our body.
- D Systems E and G work together so that digested food can be transported to other parts of the body.

Which of the following statements above are **wrong**?

- (1) A and D only
- (2) B and C only
- (3) B, C and D only
- (4) A, B, C and D

17. Study the flowchart about the digestive system below.

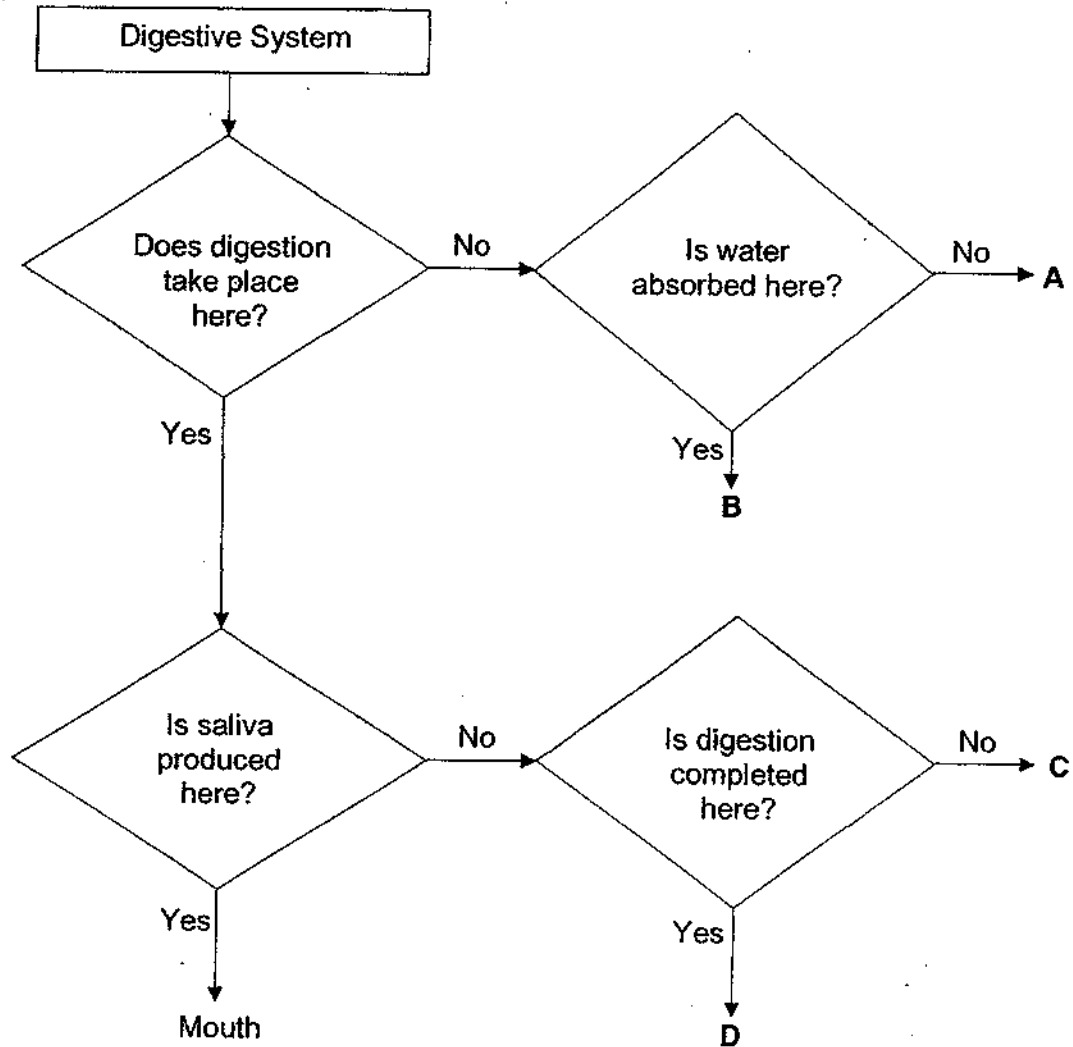

Which of the following best represents **A**, **B**, **C** and **D** of the digestive system?

	A	B	C	D
(1)	Small intestine	Large intestine	Gullet	Stomach
(2)	Gullet	Stomach	Large intestine	Small intestine
(3)	Large intestine	Stomach	Small intestine	Gullet
(4)	Gullet	Large intestine	Stomach	Small intestine

18. The diagram below shows the life cycle of an animal.

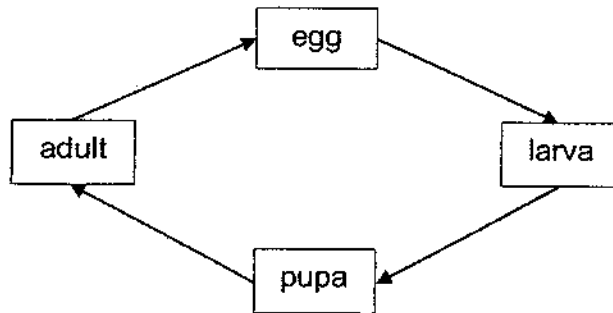

Which one of the following animals has a similar life cycle to the above?

- (1) Frog
- (2) Butterfly
- (3) Cockroach
- (4) Grasshopper

19. The table below shows the characteristics of an animal.

A tick (✓) shows that the animal has that characteristic.

Characteristics	Animal A	Animal B
Has three stages in its life cycle	✓	✓
Moults several times as it grows		✓
Adult lives on both land and in water	✓	

Which of the following could be Animals A and B?

	Animal A	Animal B
(1)	mosquito	cockroach
(2)	frog	cockroach
(3)	butterfly	beetle
(4)	mosquito	beetle

20. The set-up below shows sheets E, F and G. The three sheets are arranged in a straight row. All three sheets are of the same thickness and made of different materials. Sheet G has a triangular cut-out as shown in the diagram below.

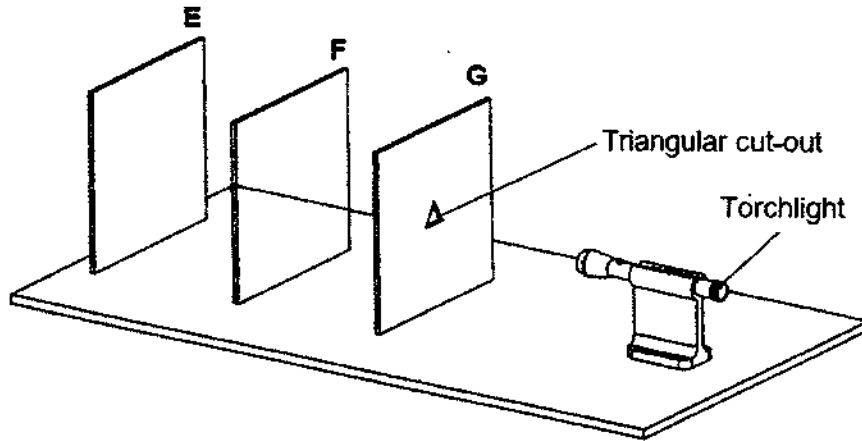

When the torchlight was switched on, light was shone through the hole and a bright triangular shaped light patch was formed on sheet E.

Based on the above observation, which of the following sheet(s) do(es) not allow light to pass through?

- (1) E only
- (2) F only
- (3) E and G only
- (4) F and G only

21. The diagram below shows how a shadow of the ball was being cast on the wall.

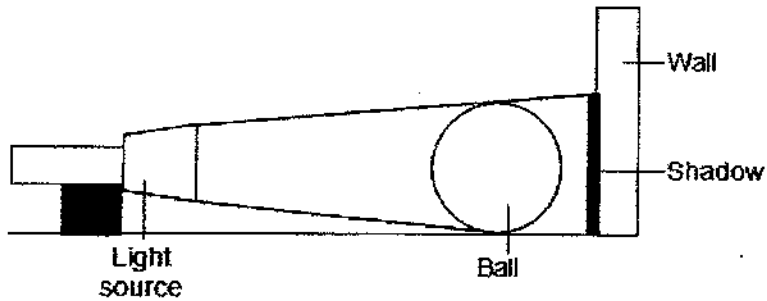

The ball was shifted to four different positions, A, B, C and D. The size of the shadow cast was measured each time and recorded in the table below.

Position of the ball	Height of shadow (cm)
A	3
B	8
C	5
D	14

At which position was the ball nearest to the wall?

- (1) A
- (2) B
- (3) C
- (4) D

22. John placed a cup of cold water at 10°C in a room at 25°C for 4 hours. Which of the following graphs correctly shows the change in temperature of the water over the 4 hours?

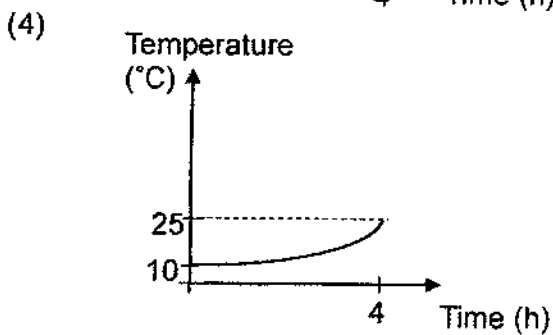
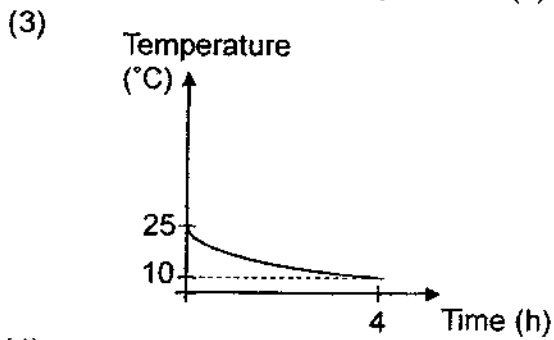
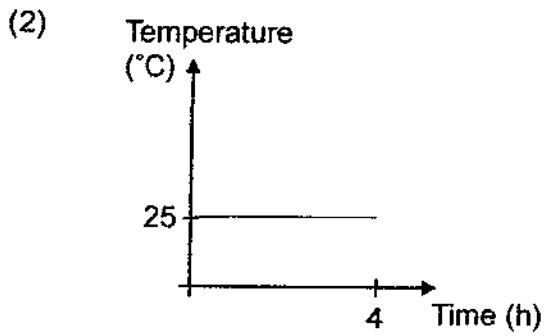
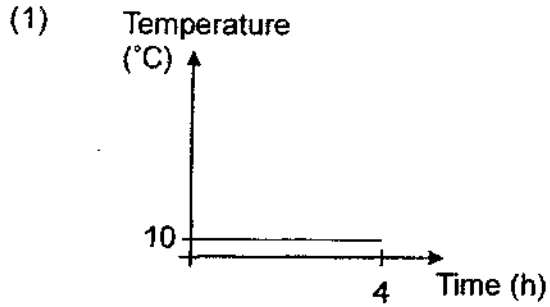

23. The diagram below shows some ice cubes in a cup of hot water.

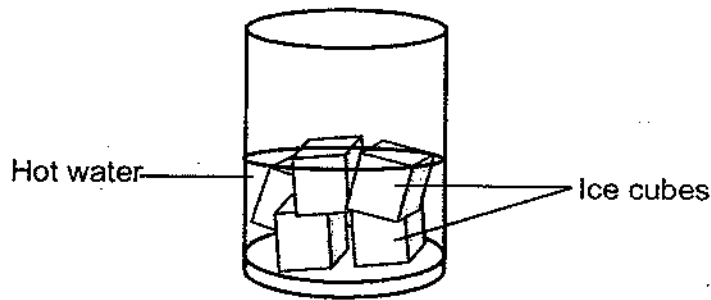

If the cup was placed in an air-conditioned room, which one of the following statements is **wrong**?

- (1) The ice cubes gain heat from the hot water.
- (2) The hot water loses heat to the ice cubes only.
- (3) The ice cubes have a lower temperature than the hot water.
- (4) A thermometer could be used to measure the temperature of the water.

24. The table below states some characteristics of substance X and Y.

Substance X	Substance Y
Does not take the shape of the container	Takes the shape of the container
Cannot be compressed	Can be compressed

Based on the characteristics above, which one of the following statements about substances X and Y is correct?

- (1) Both have a definite shape.
- (2) Both have a definite volume.
- (3) Substance X is most likely a solid while substance Y is a gas.
- (4) Substance X is most likely a gas while substance Y is a liquid.

25. Sally has two beakers, A and B. She transferred all the water and the same metal block from beaker A to beaker B. The diagram below shows the amount of water in each of the beakers.

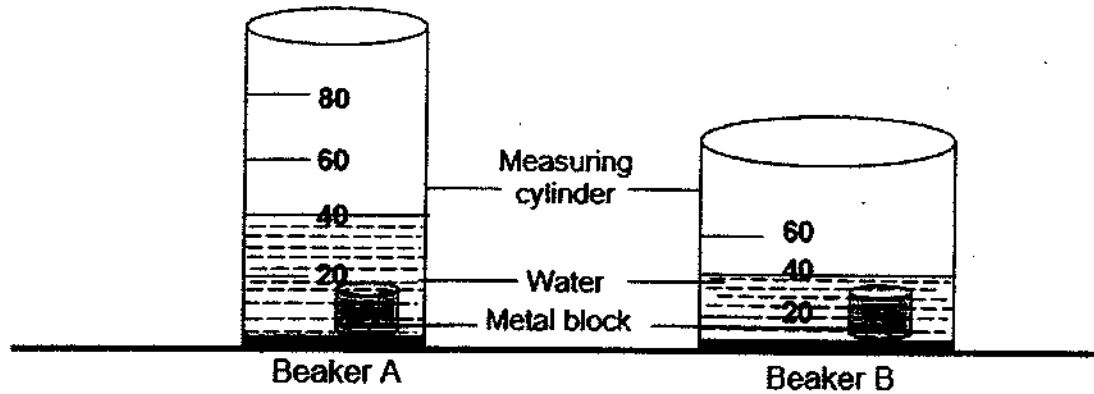

Sally made the following observations:

- A Water has a definite shape.
- B Water has a definite volume.
- C The metal block has a definite shape.
- D The metal block has a definite volume.

Based on the set-ups, which of the observation(s) made is/are **wrong**?

- (1) A only
- (2) C only
- (3) B, C and D only
- (4) All of the above

26. Miss Chua used material Z to make a part of the objects as shown in the diagram below.

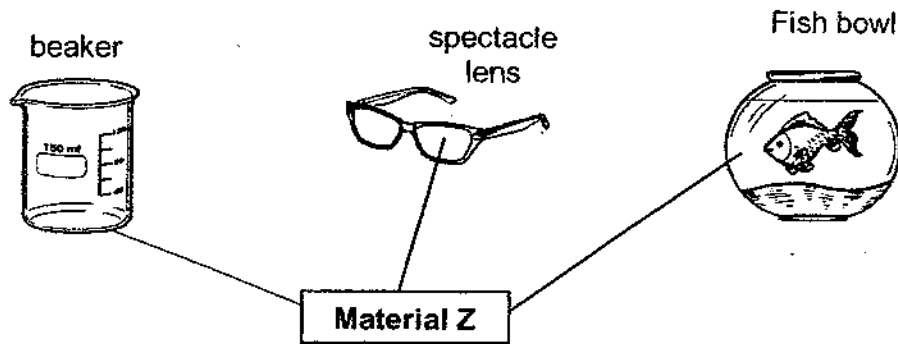

Based on your observation, which property/properties of material Z is/are necessary for the use of each object above?

- A Flexible
 - B Waterproof
 - C Able to float
 - D Allows most light to pass through
-
- (1) A and B only
 - (2) A and C only
 - (3) B and D only
 - (4) C and D only

27. The ends of two objects, A and B, were labelled and brought very near to the North pole of a bar magnet as shown in the diagram below.

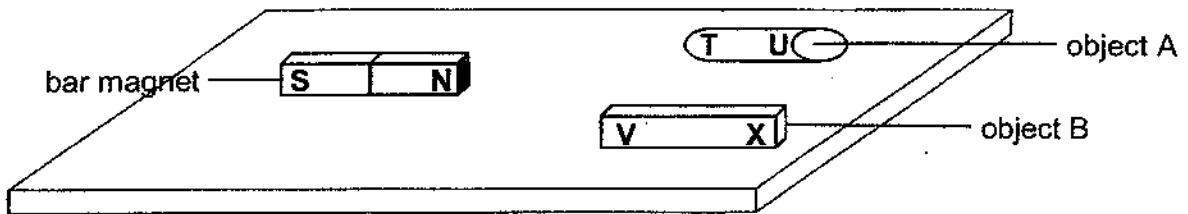

The results of the experiment are recorded in the table below. A tick (✓) shows the observable results.

Object	End	Attracted to the magnet	Repelled by the magnet
A	T	✓	
	U	✓	
B	V	✓	
	X		✓

Based on the above results, which of the following statements is correct?

- (1) A and B are magnets.
- (2) A and B are non-magnetic objects.
- (3) End T of object A is the North pole of a magnet.
- (4) End X of object B is the North pole of a magnet.

28. The diagram below shows a compass and four bar magnets that are attracted to one another.

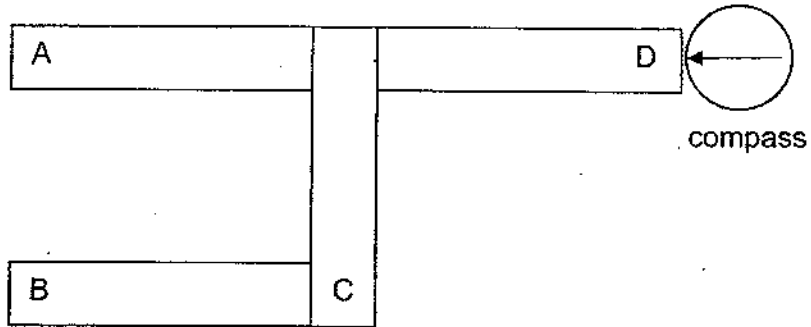

Which of the following represents the poles at **A**, **B**, **C** and **D** correctly?

	A	B	C	D
(1)	north	south	south	north
(2)	south	north	north	south
(3)	north	south	north	south
(4)	south	north	south	north

~ END OF BOOKLET A ~



NANYANG PRIMARY SCHOOL

PRIMARY 4 SCIENCE

Practice Paper

2021

BOOKLET B

Total duration for Booklets A and B: 1 h 45 min

Name: _____ ()

Class: Primary 4 ()

Parent's signature:

**DO NOT OPEN THIS BOOKLET UNTIL YOU ARE TOLD TO DO SO.
FOLLOW ALL INSTRUCTIONS CAREFULLY.**

Booklet B consists of 14 printed pages including this cover page.

Section B: Open-Ended Questions

Write your answers to Questions 29 to 40 in the spaces provided.

29. Fill in the correct parts of a plant in the table below.

	Function of plant parts	Plant parts
(a)	It makes food for the plant.	
(b)	It holds the plant upright.	

30. Aliyah places a magnet near a steel paper clip. The paper clip moves towards the magnet.

Steel Paper clip



Magnet

(a) The magnet exerts a _____ on the paper clip.

(b) Aliyah's observations in part (a) demonstrates a property of steel. Put a tick (✓) in the table below, to show the property observed.

Flexible	Magnetic	Strong

31. Look at the pictures below. Put a tick (✓) in the box(es) shown below if the object is a source of light.



Moon

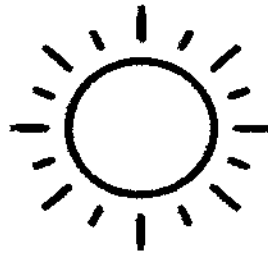

Sun

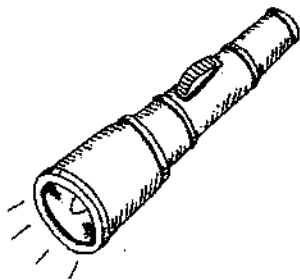

Torchlight

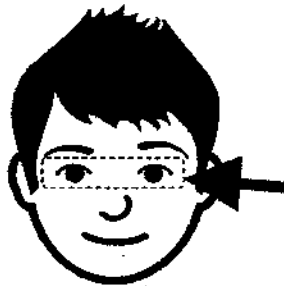

Eyes

- 32 A pot of water was placed on a stand as shown in Figure 1 below.

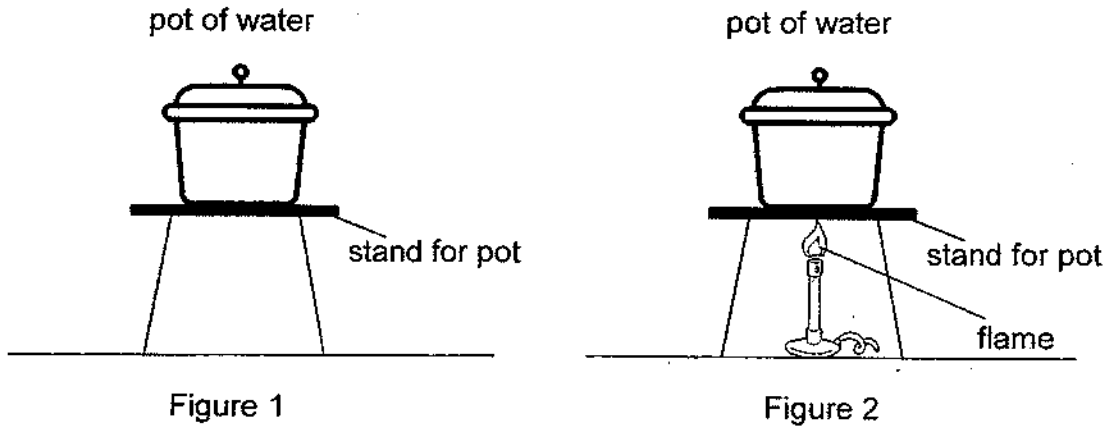

Fill in the blanks using the correct words from the box.

liquid	decreases	solid
remains unchanged	increases	gas

- (a) When a flame is placed under the pot as shown in Figure 2 above, the temperature of the water _____.
- (b) The pot of water is then removed from the flame and put into the freezer. After some time, the water will change its state to become a _____.

33. Rahul compared the mass of three objects.

Study the diagrams below and fill in the blanks using the suitable words from the box.

same as	greater than	less than
---------	--------------	-----------

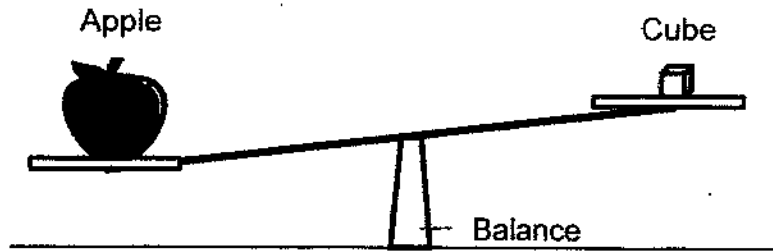

(a) The mass of the apple is _____ the mass of the cube.

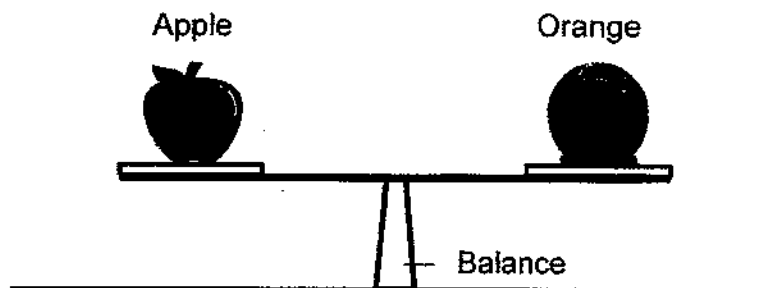

(b) The mass of the apple is _____ the mass of the orange.

34. The diagram below shows plant X and plant Y.

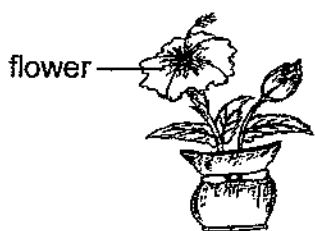

Plant X



Plant Y

(a) State one similarity in the characteristics for both X and Y.

(b) Study the classification table below.

(i) Write suitable headings for **P** and **Q**.

(ii) Classify "**Plant X**" and "**Plant Y**" into the classification table.

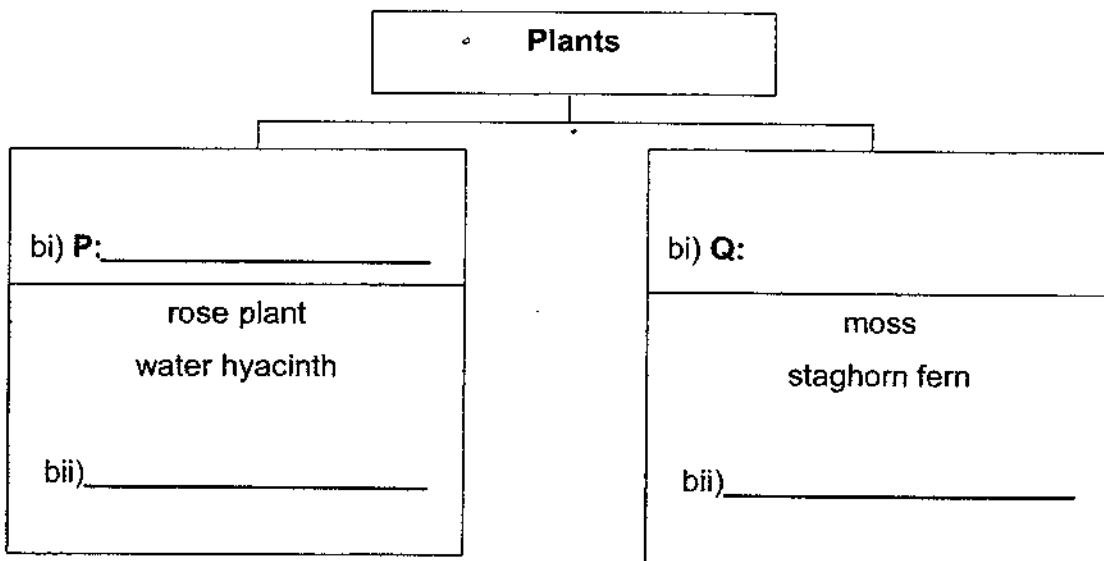

(c) Give an example of why plants are important to living things.

35. The diagram below shows two living things, insect P and amphibian Q.



Insect P



Amphibian Q

(a) State one similarity between insect P and amphibian Q.

(b) State one difference in the outer-coverings of insect P and amphibian Q.

(c) Study the flowchart below.

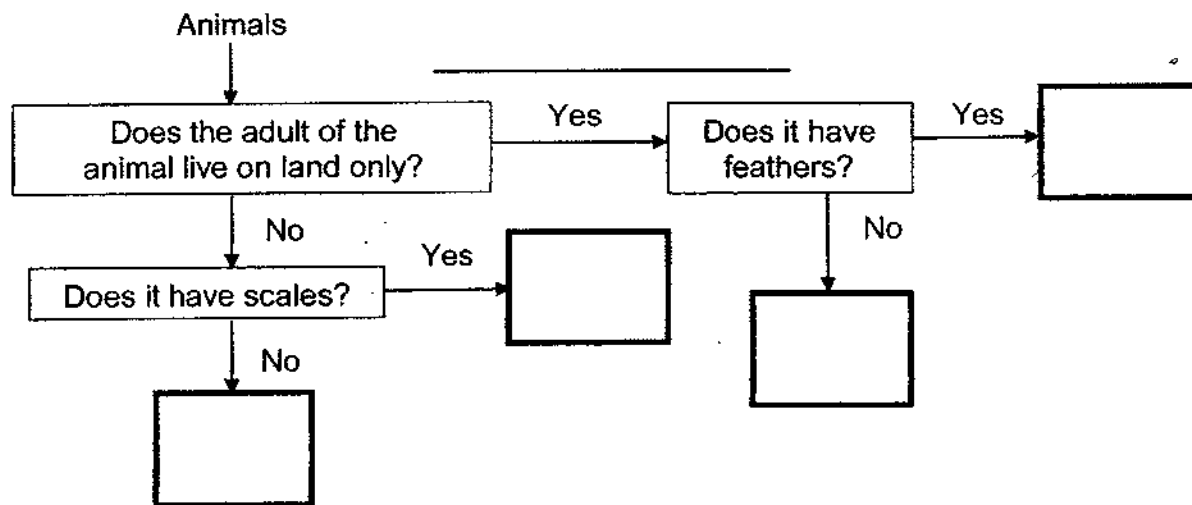

(i) Classify insect P and amphibian Q in the flowchart above. Write the letters "P" to indicate insect P and "Q" to indicate amphibian Q in the boxes correctly.

Animal R lays eggs. It has a beak and a pair of wings.

(ii) Classify animal R by writing the letter "R" in the one of the boxes correctly.

36. Amy conducted an experiment to find out if fungi grows well in bags made of different materials. She made a table to identify the variables involved in her experiment.

(a) Put a tick (✓) for variables that Amy should keep the same, change and measure for her experiment.

Variables	Keep the Same	Changed	Measured
Temperature at which the bags are kept			
Size of bags			
Material of bags			
Presence of mould			

After one week, Amy found fungi growing in some of the bags.

(b) State all the conditions required for the fungi to grow in the bags.

There are many good uses of fungi in our daily life such as to use as medicine.

(c) State another specific example of fungi and its good use.

i) Example: _____

ii) Use: _____

37. The diagram below shows part of the human digestive system.

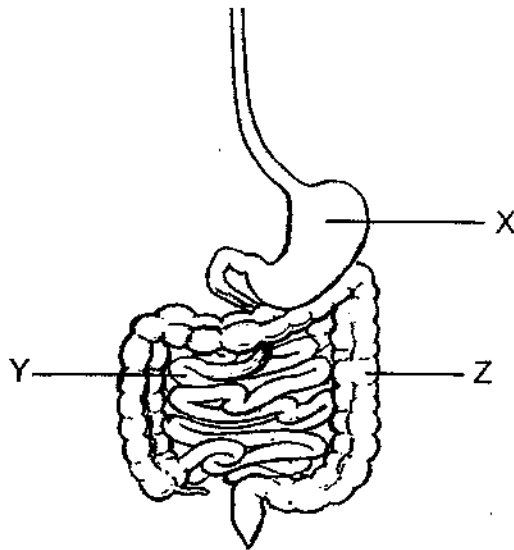

(a) State one similarity in the function of parts X and Y.

(b) State the substances that are absorbed at Y and Z.

- i) Substance absorbed at Y: _____
- ii) Substance absorbed at Z: _____

Study the table below.

(c) Put a tick (✓) to show the change in the amount of undigested food right before it leaves X, Y and Z.

Change in amount of undigested food right before it leaves the organ	X	Y	Z
No change			
Decrease			
Increase			

38. Study the flowchart below.

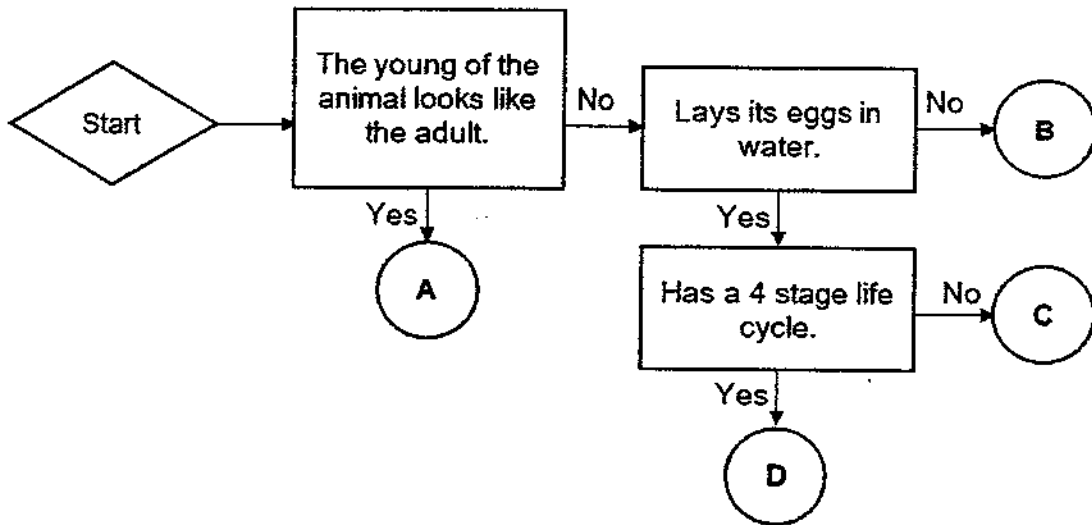

(a) Based on the flowchart above, state one similarity between animals B and C.

(b) Based on the flowchart above, state one difference between animals B and D.

(c) Give an example of the animals C and D.

i) C: _____

ii) D: _____

(d) Using some of the words from the list given below, draw the life cycle of animal A in the box provided.

Nymph	Egg	Adult
Young	Pupa	Larva

39. Tammy set up an experiment as shown below.

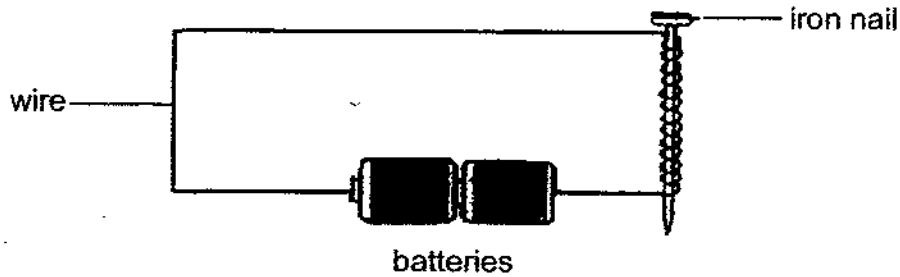

She measured the magnetic strength of the electromagnet by counting the number of steel clips the electromagnet could attract. She recorded the results in the table below.

Number of coils of wire around the iron nail	Number of steel clips attracted
10	9
20	X
30	24
40	31

(a) What is the aim of the experiment?

(b) State a possible value for X.

Tammy then removed one battery from the set up and brought it near the steel clips.

(c) State the observation that Tammy would most likely make.

(d) Suggest another method of making a temporary magnet.

41. Jenny had two identical glass cups stacked together as shown in the diagram below.

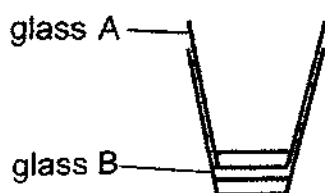

She had difficulties separating the cups as they were stuck together.

(a) i) Without breaking any of the cups, suggest a way to separate the two cups.

ii) Explain your answer in a(i).

Jenny has a plastic cup and a metal cup of the same size. She poured the same amount of water at 100°C into the two cups. She measured the change of temperature of the water over 30 minutes. The table below shows her results.

Time (min)	Temperature (°C)	
	Plastic cup	Metal cup
5	80	68
10	70	40
15	55	32
20	48	28
25	40	Z
30	34	25

(b) Suggest a possible value for Z.

_____ °C

40. Marvin tried to pour milk out from two identical metal cans, J and K. He made a small hole on the top of can J and a larger hole on the top of can K as shown in the diagram below.

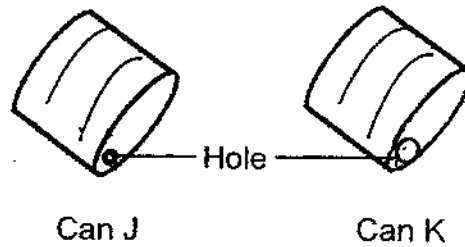

- (a) In which can, J or K, will the milk flow out faster? Explain why.

Marvin wanted to find out how he can speed up the amount of milk poured out from the can. He made one hole on the lid of can A, two holes on the lid of can B and three holes on the lid of can C. All the holes are of the same size. He recorded the amount of milk poured out from cans A and C over a period of 5 minutes.

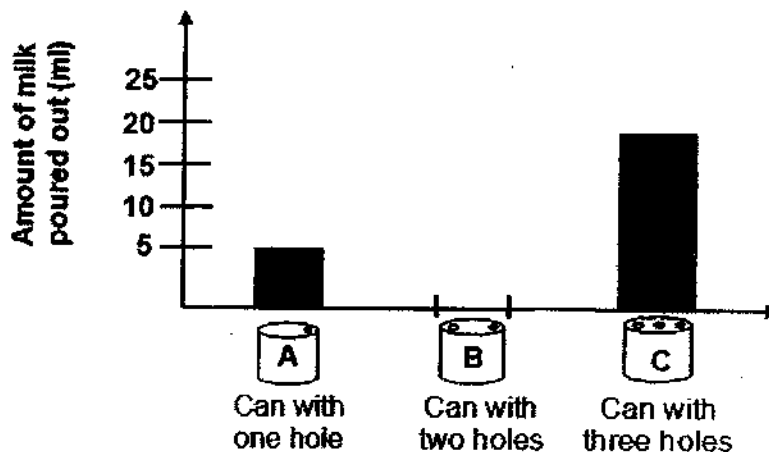

- (b) In the graph above, draw a bar to show the possible amount of milk poured out of can B.
- (c) What is the changed variable in Marvin's experiment?
- (d) Why did Marvin have to ensure that the size of holes made on the cans are the same?

Jenny had three identical plastic beakers, P, Q and R, with an identical uncooked egg placed in each beaker. She then filled the beakers with different amounts of water at 100°C, as shown in the diagram below.

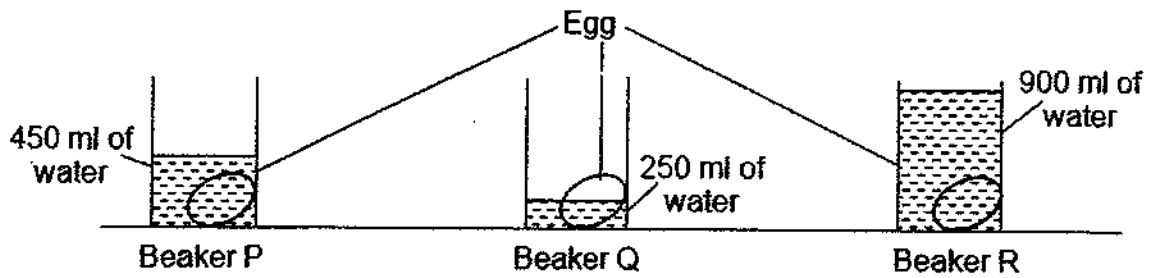

- (c) After 10 minutes, in which beaker would the egg be the most cooked?
Explain your answer.

~ END OF BOOKLET B ~

Nanyang Primary School
P4 SCIENCE Practice Paper 2021 - Suggested Answer Key

Section A

1	3	11	2	21	1
2	2	12	1	22	4
3	3	13	2	23	2
4	1	14	1	24	3
5	3	15	2	25	1
6	1	16	2	26	3
7	2	17	4	27	4
8	4	18	2	28	2
9	3	19	2		
10	1	20	3		

Section B

Qn No	Acceptable Answers						
29a.	Leaf / Leaves						
29b.	Stem						
30a.	pull / force						
30b.	<table border="1" style="width: 100%; text-align: center;"> <tr> <td>Flexible</td> <td>Magnetic</td> <td>Strong</td> </tr> <tr> <td></td> <td>✓</td> <td></td> </tr> </table>	Flexible	Magnetic	Strong		✓	
Flexible	Magnetic	Strong					
	✓						
31.	To tick: - Sun - Torchlight						
32a.	increases						
32b.	solid						
33a.	greater than						
33b.	same as						
34a.	Both can make food.						
34b.	<div style="text-align: center;"> <table border="1" style="margin: auto;"> <tr><td style="text-align: center;">Plants</td></tr> <tr><td style="text-align: center;">├── (i) P: Flowering plants</td></tr> <tr><td style="text-align: center;">└── Q: Non-flowering plants</td></tr> </table> <table border="1" style="margin: auto;"> <tr> <td style="width: 50%; text-align: center;"> rose plant water hyacinth (ii) Plant X </td> <td style="width: 50%; text-align: center;"> moss staghorn fern (ii) Plant Y </td> </tr> </table> </div>	Plants	├── (i) P: Flowering plants	└── Q: Non-flowering plants	rose plant water hyacinth (ii) Plant X	moss staghorn fern (ii) Plant Y	
Plants							
├── (i) P: Flowering plants							
└── Q: Non-flowering plants							
rose plant water hyacinth (ii) Plant X	moss staghorn fern (ii) Plant Y						
34c.	Plants provide food for many living things.						

35a.	Both lay eggs.																				
35b.	Insect P has hard outer-covering but Amphibian Q has moist skin.																				
35c.	<p>(i) & (ii)</p> <pre> graph TD A[Animals] --> B{Does the adult of the animal live on land only?} B -- Yes --> C{Does it have feathers?} C -- Yes --> R["(ii) R"] C -- No --> P["P"] B -- No --> D{Does it have scales?} D -- Yes --> I["(i)"] D -- No --> Q["(i) Q"] </pre>																				
36a.	<table border="1"> <thead> <tr> <th>Variables</th> <th>Keep the same</th> <th>Changed</th> <th>Measured</th> </tr> </thead> <tbody> <tr> <td>Temperature at which the bags are kept</td> <td>✓</td> <td></td> <td></td> </tr> <tr> <td>Size of bag</td> <td>✓</td> <td></td> <td></td> </tr> <tr> <td>Material of bag</td> <td></td> <td>✓</td> <td></td> </tr> <tr> <td>Presence of mould</td> <td></td> <td></td> <td>✓</td> </tr> </tbody> </table>	Variables	Keep the same	Changed	Measured	Temperature at which the bags are kept	✓			Size of bag	✓			Material of bag		✓		Presence of mould			✓
Variables	Keep the same	Changed	Measured																		
Temperature at which the bags are kept	✓																				
Size of bag	✓																				
Material of bag		✓																			
Presence of mould			✓																		
36b.	Air, food, water and warmth.																				
36c.	i) Mushroom ii) Can be eaten as food																				
37a.	Both break down food into simpler substances.																				
37b.	(i) digested food (ii) water																				
37c.	<table border="1"> <thead> <tr> <th>Change in undigested food when it leaves the organ</th> <th>Organ X</th> <th>Organ Y</th> <th>Organ Z</th> </tr> </thead> <tbody> <tr> <td>No change</td> <td></td> <td></td> <td>✓</td> </tr> <tr> <td>Decrease</td> <td>✓</td> <td>✓</td> <td></td> </tr> <tr> <td>Increase</td> <td></td> <td></td> <td></td> </tr> </tbody> </table>	Change in undigested food when it leaves the organ	Organ X	Organ Y	Organ Z	No change			✓	Decrease	✓	✓		Increase							
Change in undigested food when it leaves the organ	Organ X	Organ Y	Organ Z																		
No change			✓																		
Decrease	✓	✓																			
Increase																					
38a.	Both the young of the animals do not look like the adult.																				
38b.	Animal B does not lay eggs in water while animal D lays eggs in water.																				
38c.	i) Frog ii) Mosquito																				

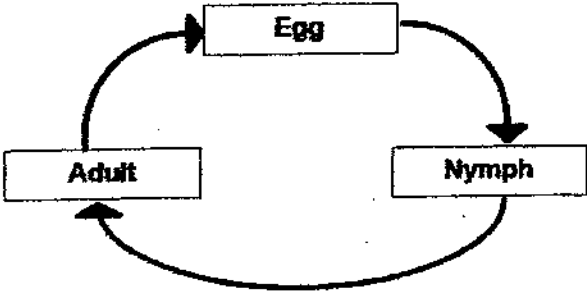
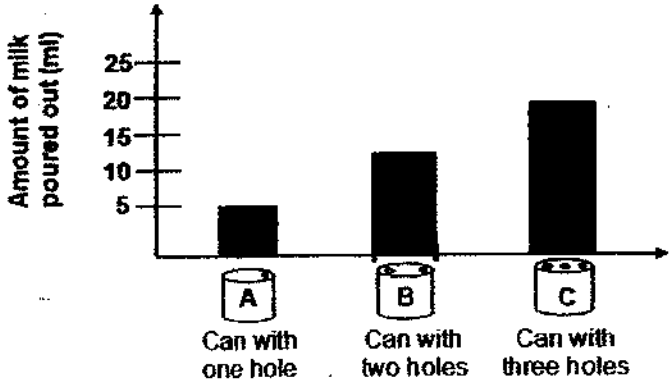
38d.	 <pre> graph TD Egg --> Nymph Nymph --> Adult Adult --> Egg </pre>												
39a.	To find out if the number of coils of wire around the iron nail would affect the strength of the electromagnet.												
39b.	10-23												
39c.	Lesser steel clips will be attracted to the electromagnet.												
39d.	Stroking method.												
40a.	Can K. It has a larger hole. More air can enter the can to take up space.												
40b.	 <table border="1"> <caption>Amount of milk poured out (ml)</caption> <thead> <tr> <th>Can</th> <th>Number of Holes</th> <th>Amount of Milk Poured Out (ml)</th> </tr> </thead> <tbody> <tr> <td>A</td> <td>one hole</td> <td>5</td> </tr> <tr> <td>B</td> <td>two holes</td> <td>13</td> </tr> <tr> <td>C</td> <td>three holes</td> <td>20</td> </tr> </tbody> </table> <p>(Between values of 6-19 on the Y-axis.)</p>	Can	Number of Holes	Amount of Milk Poured Out (ml)	A	one hole	5	B	two holes	13	C	three holes	20
Can	Number of Holes	Amount of Milk Poured Out (ml)											
A	one hole	5											
B	two holes	13											
C	three holes	20											
40c.	The number of holes made.												
40d.	To ensure that it is a fair test by keeping the size of holes as the constant variable.												
41a.	i) Put ice into cup A while cup B is placed in a basin of hot water. ii) Cup A will contract as it loses heat to the ice while cup B will expand as it gains heat from the hot water.												
41b.	26 / 27 (°C)												
41c.	Beaker R. R has the most amount of water at 100°C. R contains the most heat that is transferred to the egg.												

3
END